

**Operation Manual** (EN)  
Translation of the german original manual

## WOB-L<sup>®</sup> Piston pumps

Models:

- ▶ 2522C-02 (230V / 50Hz)
- ▶ 2522B-01 (115V / 60Hz)
  
- ▶ 2534C-02 (230V / 50Hz)
- ▶ 2534B-01 (115V / 60Hz)
  
- ▶ 2546C-02 (230V / 50Hz)
- ▶ 2546B-01 (115V / 60Hz)



**Gardner Denver Thomas GmbH**

Am Vogelherd 20

98693 Ilmenau

Germany

T +49 3677 604 0

F +49 3677 604 131

[welch.emea@gardnerdenver.com](mailto:welch.emea@gardnerdenver.com)

[www.welchvacuum.com](http://www.welchvacuum.com)

Customer Support +49 3677 604 0

We are constantly working on the further development of all our product models. Reprinting or reproduction of this manual, including extracts, is not allowed without the prior written permission of Co. Gardner Denver ThomasGmbH.

All rights under the copyright laws are expressly reserved by Co. Gardner Denver Thomas GmbH.

We reserve the right to make changes and amendments.

## Contents

<b>1</b>	<b>Important Information</b> .....	<b>4</b>
1.1	General Information .....	4
1.2	Target Groups .....	4
1.3	Intended Use.....	4
1.4	Use for an Unauthorized Purpose .....	4
1.5	Safety Devices .....	5
1.6	Meaning of the Warning notes .....	5
1.7	Product Standards, Safety Regulations .....	5
<b>2</b>	<b>Basic Safety Instructions</b> .....	<b>6</b>
2.1	General Information .....	6
2.2	Electricity.....	6
2.3	Mechanical Systems .....	6
2.4	Hazardous Substances.....	7
2.5	High Temperatures .....	7
<b>3</b>	<b>Description</b> .....	<b>8</b>
3.1	Design .....	8
3.1.1	Connections - Suction-/Pressure side .....	8
3.1.2	Connecting to the electricity supply .....	8
3.1.3	Display - Vacuum- / Pressure Regulator .....	9
3.2	Additional protection measures against liquids in the pump.....	9
3.2.1	Condensate separator (Suction side) .....	9
3.2.2	Cold trap (Suction side) .....	9
3.3	Areas of Application .....	10
3.4	Materials of the medium-affecting pump parts.....	10
3.5	Scope of Delivery .....	10
3.6	Accessories.....	10
<b>4</b>	<b>Technical Data</b> .....	<b>11</b>
<b>5</b>	<b>Installation and Operation</b> .....	<b>12</b>
5.1	Unpacking .....	12
5.2	Setting up and connecting .....	12
5.2.1	Setting up .....	12
5.2.2	Connecting.....	12
5.2.2.1	Electrical Connection .....	12
5.2.2.2	Vacuum connection (Suction side) .....	12
5.2.2.3	Exhaust connection (Pressure side) .....	13
5.3	Operation .....	13
5.3.1	Start-up .....	13
5.3.2	Decommissioning.....	13
5.4	Storage.....	14
5.5	Scrap Disposal .....	14
<b>6</b>	<b>Maintenance and Servicing</b> .....	<b>15</b>
6.1	Maintenance Performed by the User .....	15
6.2	Maintenance by the Manufacturer .....	15
6.3	Damage Report.....	15
<b>7</b>	<b>Troubleshooting</b> .....	<b>16</b>
<b>8</b>	<b>Spare Parts Overview</b> .....	<b>17</b>
8.1	Kit – Order numbers.....	17
8.2	Spare parts view / Parts lists 2522C-02, 2522B-01, 2534B-01 .....	18
8.3	Spare parts view / Parts lists 2534C-02.....	19
8.4	Spare parts view / Parts lists 2546C-02, 2546B-01 .....	20

### EC Declaration of Conformity

# Important Information

## 1 Important Information

### 1.1 General Information

The **WOB-L<sup>®</sup> Piston Pumps** conform to the following directives:

<b>2006 / 42 / EC</b>	Machinery Directive
<b>2014 / 30 / EU</b>	Electromagnetic Compatibility Directive
<b>2014 / 68 / EU</b>	Pressure Equipment Directive
<b>2014 / 29 / EU</b>	Simple Pressure Vessels Directive

The CE sign is located on the rating plate.

Observe the binding national and local regulations when fitting the pump into installations!

### 1.2 Target Groups

This Operating Manual is intended for the personnel planning, operating and maintaining WOB-L<sup>®</sup> Piston Pumps.

This group of people includes:

- Designers and fitters of vacuum apparatus
- Employees working on commercial laboratory and industrial vacuum technology applications
- Service personnel for WOB-L<sup>®</sup> Piston Pumps

The personnel operating and maintaining the WOB-L<sup>®</sup> Piston Pumps must have the technical competence required to perform the work that has to be done.

The user must authorize the operating personnel to do the work that has to be done.

The personnel must have read and understood the complete Operating Manual before using the WOB-L<sup>®</sup> Piston Pumps.

The Operating Manual must be kept at the place of use and be available to the personnel when required.

### 1.3 Intended Use

- The layout of the WOB-L<sup>®</sup> Piston Pumps must be appropriate for the conditions of use. The user bears the sole responsibility for this.
- The WOB-L<sup>®</sup> Piston Pumps may only be operated under the conditions stated
  - in the "Technical Data" section,
  - on the type plate, and
  - in the technical specification for the order concerned.
- WOB-L<sup>®</sup> Piston Pumps are approved for extracting, pumping and compressing gases and vapours. If these gases and vapours are toxic or explosive, then the user must observe the currently valid safety regulations for this application.

### 1.4 Use for an Unauthorized Purpose

It is forbidden to use the pump for applications deviating from the technical data stated on the type plate or the conditions stated in the supply contract, or to operate it with missing or defective protective devices.

## 1.5 Safety Devices

Measures such as the following are for the safety of the operating personnel:

- electrical connection with a protective conductor (operating mode S1) and an earthing plug
- Motor protection device (thermal)
- "Hot Surface" label on the pump - warning notice 

The WOB-L<sup>®</sup> Piston Pumps must not be operated without these elements.

## 1.6 Meaning of the Warning notes

Take note of the warning notices. They are each in the following box:

	<b>CAUTION ! / WARNING !</b>
<b>Hazard which may lead to serious injuries or material damage.</b>	

## 1.7 Product Standards, Safety Regulations

**WOB-L<sup>®</sup> Piston Pumps meet the following product standards:**

<b>DIN EN ISO 12100:2011-03</b>	Safety of machinery - General principles for design - Risk assessment and risk reduction
<b>DIN EN ISO 13857:2008-06</b>	Safety of machinery - Safety distances to prevent hazard zones being reached by upper and lower limbs
<b>DIN EN 1012-1:2011-02</b> <b>DIN EN 1012-2:2011-12</b>	Compressors and Vacuum pumps - Safety requirements - Part 1: Compressors Part 2: Vacuum pumps
<b>DIN EN ISO 2151:2009-01</b>	Acoustics - Noise test code for compressors and vacuum pumps - Engineering method (grade 2)
<b>DIN EN 60204-12014-10</b>	Safety of machinery - Electrical equipment of machines - Part 1: General requirements
<b>DIN EN 61000-6-2:2011-06</b> <b>DIN EN 61000-6-4:2011-09</b>	Electromagnetic compatibility (EMC) - Part 6-2: Generic standards - Immunity for industrial environments Part 6-4: Generic standards - Emission standard for industrial environments
<b>DIN EN 61010-1/A1:2015-04</b>	Safety requirements for electrical equipment for measurement, control and laboratory use - Part 1: General requirements
<b>DIN EN 50110-1:2014-02</b>	Operation of electrical installations
<b>Directive 2012/19/EU</b>	Electrical and electronics - old devices (WEEE)
<b>Directive 2011/65/EU</b>	Dangerous materials in electrical and electronics devices (RoHS II)
<b>China - RoHS II</b>	Environment protection law - China 2016-01

**The following additional safety regulations apply in the FR Germany:**

<b>BGV A3</b>	Electrical equipment and operating materials
<b>VBG 5</b>	Power-driven machines
<b>BGR 120</b>	Guidelines for laboratories
<b>BGI 798</b>	Hazard assessment in the laboratory
<b>BGG 919 (VBG 16)</b>	Accident prevention regulations for "compressors"
<b>BGR 189 (BGR 195;192;197)</b>	Use of protective working clothes

Observe the standards and regulations applying in your country when you use the WOB-L<sup>®</sup> Piston Pumps.

# Basic Safety Instructions

## 2 Basic Safety Instructions

### 2.1 General Information

Warning notices must be observed. Disregarding them may lead to damage to health and property.

The WOB-L<sup>®</sup> Piston Pumps must be operated by personnel who can detect impending dangers and take action to prevent them from materialising.

The manufacturer or authorized workshops will only service or maintain the WOB-L<sup>®</sup> Piston Pumps if it is accompanied by a fully completed damage report. Precise information about the contamination (also negative information if necessary) and thorough cleaning of the WOB-L<sup>®</sup> Piston Pumps are legally binding parts of the contract. Contaminated WOB-L<sup>®</sup> Piston Pumps and their individual parts must be disposed of in accordance with the legal regulations.

The local regulations apply in foreign countries.

### 2.2 Electricity

The WOB-L<sup>®</sup> Piston Pumps of operation mode S1 are supplied. When the location of operation mode S1 devices is changed, please note that the testing must be repeated in accordance with DIN EN 0105, DIN EN 0702 and BGV A2.

The local regulations apply in foreign countries.

Please note the following when connecting to the electrical power supply system:

- The electrical power supply system must have a protective connector according to DIN VDE 0100-410 (IEC 60364-4-41).
- The protective connector must not have any breaks.
- The connecting cable must not be damaged.

### 2.3 Mechanical Systems

Improper use can lead to injuries or material damage. Observe the following instructions:

- Only operate the pumps with hoses of the specified dimensions.
- The maximum permissible pressure of 1 bar at the suction connection must not be exceeded.
- Hazardous substances must be separated out as far as this is technically possible before they reach the pump.
- External mechanical stresses and vibrations must not be transmitted to the pump. Only use flexible laboratory hoses for connecting pumps.
- The overpressure generated at the pressure port must not exceed 7 bar.
- The pump must not be used to suck up fluids. Lay the exhaust pipe so that it slopes downwards, so allowing condensate to flow out of the pump. Collect the condensate and dispose of it in an environmentally compatible manner.
- Prevent dyes exuding.
- Maintain a space of least 20 mm between the pump and adjacent parts in order to enable the pump to cool.

	<b>CAUTION !</b>
<b>Solid particles in the pumping medium impair the pumping action and can lead to damage. Prevent solid particles penetrating into the pump.</b>	

## 2.4 Hazardous Substances

	<b>ACHTUNG !</b>
<p><b>The operating company bears the responsibility for the use of the WOB-L<sup>®</sup> Piston Pumps.</b> <b>Hazardous substances in the gases to be pumped can cause personal injuries and property damage. Pay attention to the warning notices for handling hazardous substances.</b></p>	

The local regulations apply in foreign countries.

### Combustible, aggressive and explosive Gases

Don't pump combustible, especially aggressive or explosive gases or vapors or operate this pump in an atmosphere containing combustible or explosive gases or vapors.

Examine before switching on whether that can form gas combustible gas/air mixtures which can be promoted! Consider the regulations of the guideline 1999/92/EC.

The WOB-L<sup>®</sup> Piston Pumps are not certified according to ATEX guidelines 2014/34/EU.

The WOB-L<sup>®</sup> piston pumps are not recommended for pumping acidic, basic or organic vapors.

### Poisonous Gases

Use a separator when pumping poisonous or harmful gases. Prevent such substances from leaking out of the appliance or pump. Treat these substances according to the applicable environmental protection regulations.

Test the strength and leak-tightness of the connecting lines and the connected apparatus. Prevent environmental poisons, e.g. mercury, getting into the pumps.

Fulfil the requirements, for example:

- German Hazardous Substances Regulation (GefStoffV) of 01. December 2010
- Regulation 2016/1179/EU (classification, packaging and labelling of hazardous substances),
- Manufacturer's safety data sheets on hazardous substances.

## 2.5 High Temperatures

The WOB-L<sup>®</sup> Piston Pumps may heat up as a result of the temperature of the gas being pumped and through compression heat.

Prevent the following maximum permissible temperatures from being exceeded.

- + 40 °C for the environment, and
- + 60 °C for the gas to be pumped.

The electric motor has a thermal overload protection.

# Description

## 3 Description

### 3.1 Design

#### 3.1.1 Connections - Suction-/Pressure side

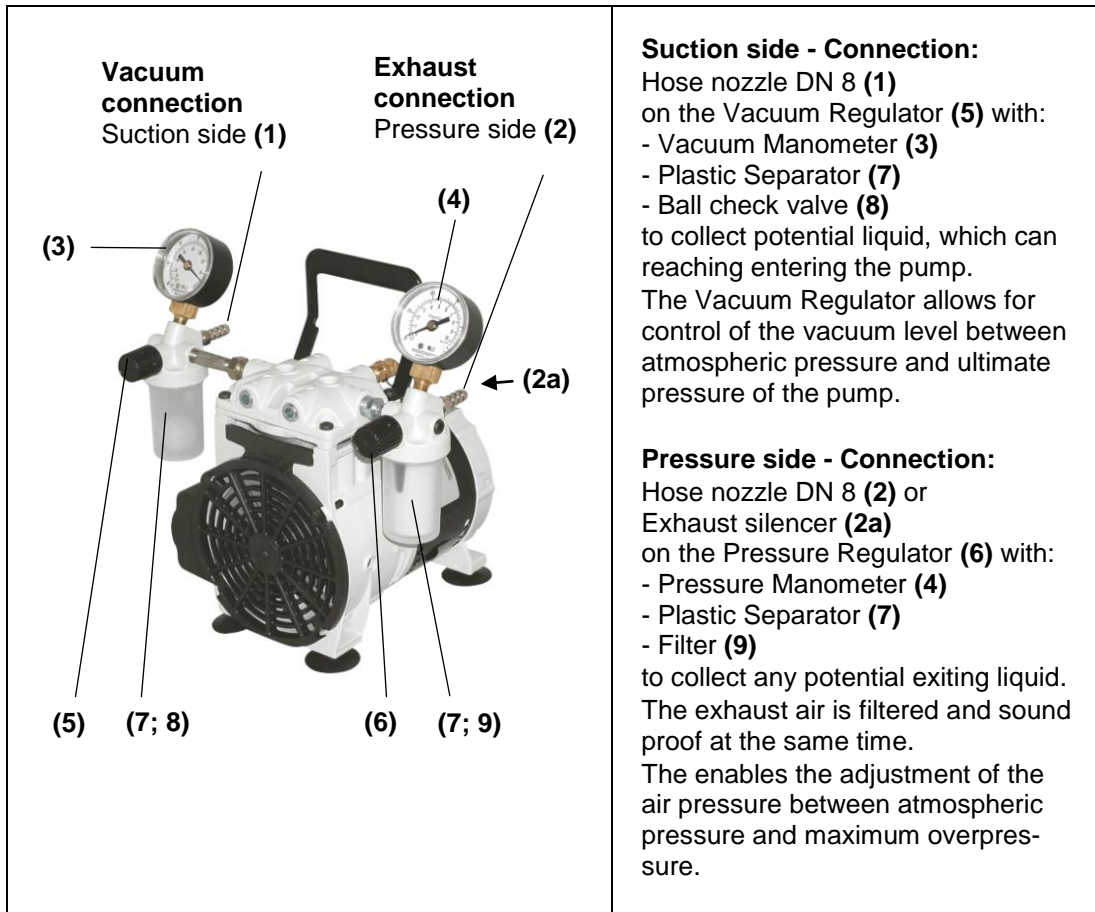



Fig. 1 Design WOB-L<sup>®</sup> Piston Pump (2546)

#### 3.1.2 Connecting to the electricity supply

The WOB-L<sup>®</sup> Piston Pumps are supplied with complete electrical wiring. It is connected via a mains connection cable and a power plug. Mains connection cable and plug must comply with the requirements of the line disconnection devices (current, output). Motor is provided with a thermal overload protection ex works, protecting the vacuum pump from damage or destruction, respectively.

	<p><b>WARNING !</b></p>
<p><b>Should the user change the electrical connection, for example for fitting into a system, then this may only be performed by a electrical specialist under observance of the accident prevention regulations.</b></p>	



### 3.1.3 Display - Vacuum- / Pressure Regulator

The Vacuum Regulator shows pressures at below atmospheric pressure.  
The Pressure Regulator gives pressure above atmospheric.  
The reference point for both gauges is atmospheric pressure.

	<b>WARNUNG !</b>
<p><b>Please keep in mind that the barometric pressure changes from day to day. This also changes the displayed pressure values because of latent air pressure fluctuations.</b></p>	

## 3.2 Additional protection measures against liquids in the pump

### 3.2.1 Condensate separator (Suction side)

To prevent accidental ingress of liquids (condensate) in the pump, a plastic separator with ball check valve is mounted on the suction side regulator.

If the possibility of penetration of larger liquid quantities which exceed the capacity of the separator, we recommend the additional installation (*Fig. 2*) of a larger collection vessel (eg. Woulff bottle).

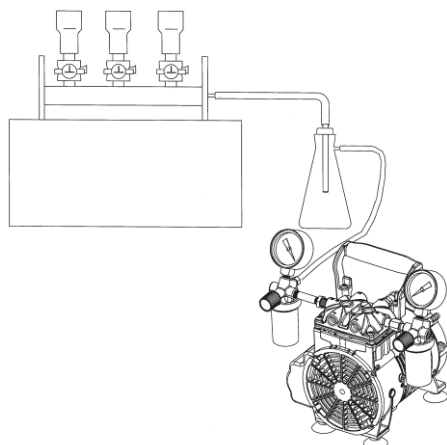

*Fig. 2 Additional separation vessel between the pump and apparatus*

### 3.2.2 Cold trap (Suction side)

The installation of an appropriate cold trap is required when a larger amount of steam (water, solvent) is obtained which exceeds the tolerance of the vapor pump.

The refrigerant used is usually dry ice or dry ice mixture with an acetone or alcohol.

#### **Maintenance:**

The refrigerant must have the highest possible level in the cold trap.

The rise in pressure in the connected vacuum apparatus indicates that the cold trap is saturated.

For cleaning remove the cold trap and defrost. The condensate must be disposed of properly. The cool trap is, if applicable, clean with a detergent and dry.

## Description

### 3.3 Areas of Application

The WOB-L<sup>®</sup> Piston Pumps are intended to:

- Pumping and compressing neutral and aggressive gases and vapours.
- Generating a vacuum down to a minimum ultimate pressure < 80 mbar.
- Use in physical and chemical laboratories in trade and industry.
- Use for vacuum filtration, vacuum drying, glove boxes, vacuum ovens and other vacuum technology applications.





### 3.4 Materials of the medium-affecting pump parts

Component	Materials
Seal	EPDM
Hose nozzle, Valve	Stainless steel
Piston cup seal	PTFE - Compound
Pump head	Aluminium with corrosion protection
Separator vessel	Plastic

### 3.5 Scope of Delivery

The scope of delivery is specified in the supply contract.

### 3.6 Accessories

Figure	Designation / Usage	Order no.
	<b>Inline filter, hydrophobic</b> Pore size: 0.22 µm To protect the pump against fine dust and aerosols. Installation in the suction line, as shown.	<b>112555-04</b>
	<b>Vacuum hose red, rubber</b> 18 / 8 x 5 mm For vacuum applications between pump and apparatus.	<b>828310-4</b>
	<b>PVC-Fabric hose</b> 8 x 3 mm For compressor- and vacuum applications as exhaust air- and suction line.	<b>828346</b>
	<b>Hose clamp</b> Clamping range 8 – 16 mm For fixing and sealing of PVC fabric hose.	<b>826011-9</b>

## 4 Technical Data

Parameter	Unit	2522	2534	2546
<b>Pumping speed 50/60 Hz</b> at atmospheric pressure	m <sup>3</sup> / h	1.1 / 1.3	1.7 / 2	2.3 / 2.8
	l / min	18 / 22	28 / 34	38 / 46
<b>Ultimate pressure</b>	mbar	133	93	80
<b>Overpressure, max.</b>	bar (ü)	7.9	5.8	5.2
<b>Suction connection</b>	-	Hose nozzle DN 8 for hose inside diameter 8 mm		
<b>Pressure connection</b>		Hose nozzle DN 8 for hose inside diameter 8 mm and Exhaust silencer		
<b>Ambient temperature</b>	°C	+ 10 to + 40		
<b>Max. Operating gas temperature</b>		+ 60		
<b>Noise level</b> DIN EN ISO 2151	dB (A)	≤ 56		
<b>Voltage / Frequency</b>	V / Hz	230 / 50; 115 / 60		
<b>Motor power</b>	W	93	93	190
<b>Type of protection</b> DIN EN 60529	-	IP 20		
<b>Weight</b>	kg	5.3		
<b>Dimensions (W/D/H)</b>	mm	380 / 270 / 310		
<b>Order No. for:</b>				
- <b>WOB-L® Piston pump</b> <b>230V, 50Hz</b> <i>inclusive mains connection cable with plug CEE</i>	-	<b>2522C-02</b>	<b>2534C-02</b>	<b>2546C-02</b>
- <b>WOB-L® Piston pump</b> <b>115V, 60Hz</b> <i>inclusive mains connection cable with plug US</i>		<b>2522B-01</b>	<b>2534B-01</b>	<b>2546B-01</b>

The information presented in this material is based on technical data and test results of nominal units. It is believed to be accurate and reliable and is offered as an aid to help in the selection of products. It is the responsibility of the user to determine the suitability of the product for the intended use and the user assumes all risk and liability whatsoever in connection therewith. Gardner Denver Thomas GmbH does not warrant, guarantee or assume any obligation or liability in connection with this information.

## 5 Installation and Operation

### 5.1 Unpacking

Carefully unpack the **WOB-L® Piston Pump**.

Check the pump for:

- Transport damage,
- Conformity with the specifications of the supply contract (model, electrical supply data),
- Completeness of the delivery.

Please inform us without delay if there are discrepancies between the delivery and the contractually agreed scope of delivery, or if damage is detected.

Please take note of the general terms of business of the manufacturing firm.

**In case of a claim under warranty, the device must be returned in packaging that is suitable for protecting it during transport.**

### 5.2 Setting up and connecting

#### 5.2.1 Setting up

- Set the pump on a flat and horizontal surface.
- Remove the protective caps on the suction and pressure ports.
- Note that the cooling of the pump is guaranteed, *see chapter 2.3*.
- Note that on the installation location no moisture acts on the pump.

#### 5.2.2 Connecting

##### 5.2.2.1 Electrical Connection

- Before the electrical connection of the pump review the specifications on the nameplate with the existing electrical connection conditions, *see chapter 2.2*.

	<b>CAUTION !</b>
<b>The electric motor has a thermal overload protection. After triggering the protective fuse after a certain cooling occurs an auto restart (Reset) the motor.</b>	

##### 5.2.2.2 Vacuum connection (Suction side)

- The vacuum connection (suction port) consists of a hose nozzle DN 8.  
Suitable vacuum lines are available:
  - Thick-walled rubber vacuum hose 8 x 5 mm hose nozzle DN 8.
  - PVC fabric hose and hose clamp 8 x 3 mm clamping range 8 - 16 mm.
- Make sure that the vacuum line is kept as short as possible from the pump to the apparatus.

## 5.2.2.3 Exhaust connection (Pressure side)

The exhaust connection (pressure port) also consists of a hose nozzle DN 8.

### a) *Exhaust line for vacuum applications:*

- Thick-walled rubber vacuum hose 8 x 5 mm hose nozzle DN 8.
- PVC fabric hose and hose clamp 8 x 3 mm clamping range 8 - 16 mm.

### b) *Exhaust line (compressed-air line) with compressor application:*

- PVC fabric hose and hose clamp 8 x 3 mm clamping range 8 - 16 mm.

	<b>CAUTION !</b>
<b>Use only for compressed air applications suitable conduit systems!</b>	

## 5.3 Operation

	<b>CAUTION !</b>
<b>Observe the basic safety instructions when using the WOB-L<sup>®</sup> Piston Pump, chapter 2.</b>	

### 5.3.1 Start-up

- Make sure that when you start the pump, which may arise in the connection lines condensates, cannot penetrate into the pump.  
▶ **Action: additional suction side condensate separator**
- Always try to avoid aspiration of foreign body particles!  
▶ **Action: suction side inline filter**
- The WOB-L<sup>®</sup> Piston pump is switched on the power switch.
- It is recommended to let the pump run for a few minutes before use. The warm-up improves the eligibility of the pump.

### 5.3.2 Decommissioning

- If vacuum applications with special steam load, the pump needs to run after the process with an open vacuum port about 2 minutes and rinsed with atmospheric air. This measure is used to cleaning the pump chamber and minimizes the corrosive attack wetted material pump parts.
- The WOB-L<sup>®</sup> Piston pump is switched off using the power switch.

# Installation and Operation

## 5.4 Storage

The pumps are to be stored in a low-dust, interior room within the temperature range from + 5 to + 40 °C and at a relative air humidity < 90%.

Leave the protective elements on the suction and pressure ports. Another equally good protection may be used.

## 5.5 Scrap Disposal

	<b>CAUTION !</b>
<p><b>The WOB-L<sup>®</sup> Piston Pumps must be disposed of in accordance with the 2012/19/EU guideline and the specific national regulations.</b></p> <p><b>Contaminated WOB-L<sup>®</sup> Piston Pumps must be decontaminated according to the laws.</b></p>	

## 6 Maintenance and Servicing

WOB-L<sup>®</sup> Piston pumps are 100% oil-free.  
The piston and cylinder of the pump are lubricated maintenance free.  
All bearings are sealed and permanently lubricated.

### 6.1 Maintenance Performed by the User

	<b>WARNING !</b>
<p><b>Only perform the work that is described here, and that which is permitted to be done by the user.</b> <b>All other maintenance and service work may only be performed by the manufacturer or a dealer authorized by him.</b></p> <p><b>Beware of the pump parts being possibly contaminated by hazardous substances.</b> <b>Wear protective clothing if there is contamination.</b></p> <p><b>Renew defective parts, if necessary! Do not clean with compressed air!</b></p>	

- Check the pump daily for unusual running noises and heat building up on the surface of the pump.
- Check the electrical and vacuum connections daily.

### 6.2 Maintenance by the Manufacturer

Repairs and maintenance going beyond the extent of the work described *in chapter 6.1* or reconditioning or modification may only be performed by the manufacturer or authorized workshops.

	<b>WARNING !</b>
<p><b>The user shall be liable for the consequences of an incorrect damage report or a contaminated pump. The statements in the damage report are legally binding.</b></p>	

### 6.3 Damage Report

You find the form of the damage report to the Download on our web page in the menu "service" and "Downloads". [www.welchvacuum.com](http://www.welchvacuum.com)  
If you should not have an entrance to the Internet, you can request the form also gladly with us, under phone +49 3677 604 0.

	<b>WARNING !</b>
<p><b>Incomplete or incorrectly completed damage reports may endanger the service personnel!</b> <b>Give full information in the damage report, in particular regarding a possible contaminating.</b></p>	

# Troubleshooting

## 7 Troubleshooting

During the warranty period, intervention in the WOB-L<sup>®</sup> Piston Pumps and accessory components may only be made by manufacturing firm.

Trouble	Cause	Remedy	
		by:	with:
Pump does not start	No power supply	<b>Qualified electrician</b>	Check electrical installation
	Motor defective	<b>Service workshop</b>	Exchange
Pump does not generate a vacuum or overpressure	Connected apparatus and/or connecting elements leaking	<b>User or Service workshop</b>	Identify and seal the leak, replace the seals and/or hoses if necessary.
	Pump leaking		Exchange the hoses and/or fittings if necessary.
	Pump dirty		General maintenance / Cleaning
	Valve defective		Exchange
	Valves dirty		Cleaning condensates and foreign objects out of the valves.
	Valves, seals defective or dirty		Exchange or cleaning
	loose screws	<b>User</b>	Tighten the screws
	Separator container is full		Empty the separate container
Running noise	Pump dirty	<b>User or Service workshop</b>	General maintenance / Cleaning
	Valves, seals defective or dirty	<b>User</b>	Exchange or cleaning
	loose screws or connectors		Tighten the screws and / or connectors
Cable	defective and/or brittle	<b>Qualified electrician</b>	Exchange of the cable



## 8 Spare Parts Overview

The Spare parts- and Kit lists contain all the parts and all the information necessary for ordering.

When ordering, please quote the description, quantity, serial number and order number!

	<b>CAUTION !</b>
<p><b>We are not liable for any damage caused by the installation of any parts not supplied by the manufacturer.</b></p>	

### 8.1 Kit – Order numbers

WOB-L <sup>®</sup> Piston Pump	Service-Kit	Seal-Kit	Foot-Kit
	Order no.	Order no.	Order no.
2522C-02 2522B-01 2534B-01	2522K-03	2522K-04	2500K-04
2534C-02	2546K-03	2546K-04	
2546C-02 2546B-01	2546K-03	2546K-04	

# Spare Parts Overview

## 8.2 Spare parts view / Parts lists 2522C-02, 2522B-01, 2534B-01

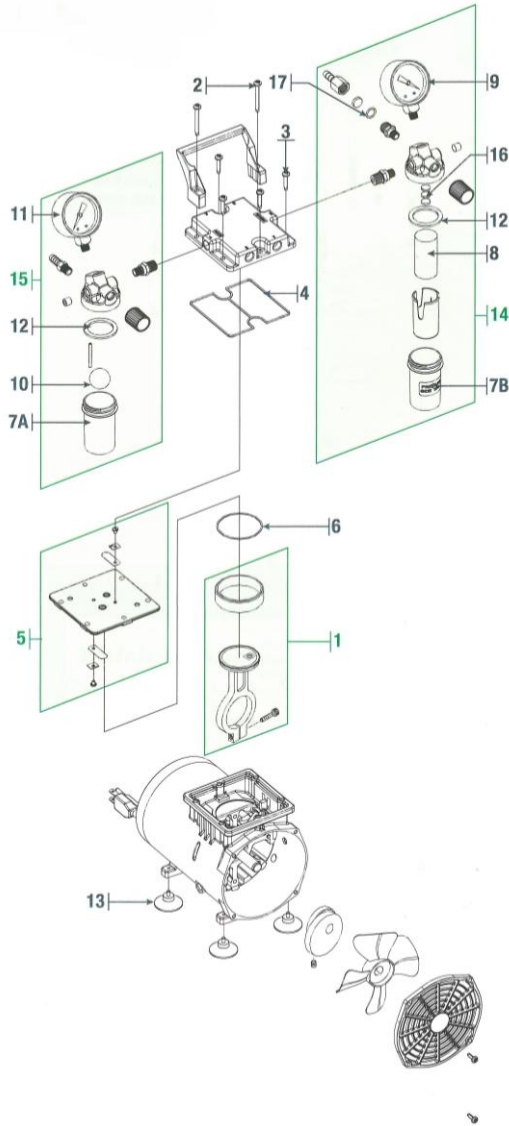

\*) These parts are not sold separately, but are only available in respective kit.

Spare parts				Service-Kit	Seal-Kit	Foot-Kit
Item	Piece	Order no.	Designation	Order no. 2522K-03	Order no. 2522K-04	Order no. 2500K-04
1	1	2522K-01	Connecting rod Assembly	1	-	-
2	1	*)	Screw, Handle	2	-	-
3	4	*)	Screw, Head	4	-	-
4	1	*)	Seal, Head	1	1	-
5	1	2565K-02	Valve plate Assembly	1	-	-
6	1	*)	O-Ring	1	1	-
7A	1	*)	Plastic Separator (suction)	1	1	-
7B	1	*)	Plastic Separator (pressure)	1	1	-
8	1	*)	Filter element	1	1	-
9	1	726026	Pressure Manometer 230 V	-	-	-
		726025	Pressure Manometer 115 V	-	-	-
10	1	*)	Ball	1	1	-
11	1	726024	Vacuum Manometer 230 V	-	-	-
		726021	Vacuum Manometer 115 V	-	-	-
12	1	*)	Seal	2	2	-
13	4	*)	Rubber suction feet	-	-	4
14	1	2522K-06	Pressure Regulator Assembly	-	-	-
15	1	2522K-05	Vacuum Regulator Assembly	-	-	-
16	3	*)	Spare filter	3	3	-
17	1	*)	O-Ring	1	1	-

## 8.3 Spare parts view / Parts lists 2534C-02

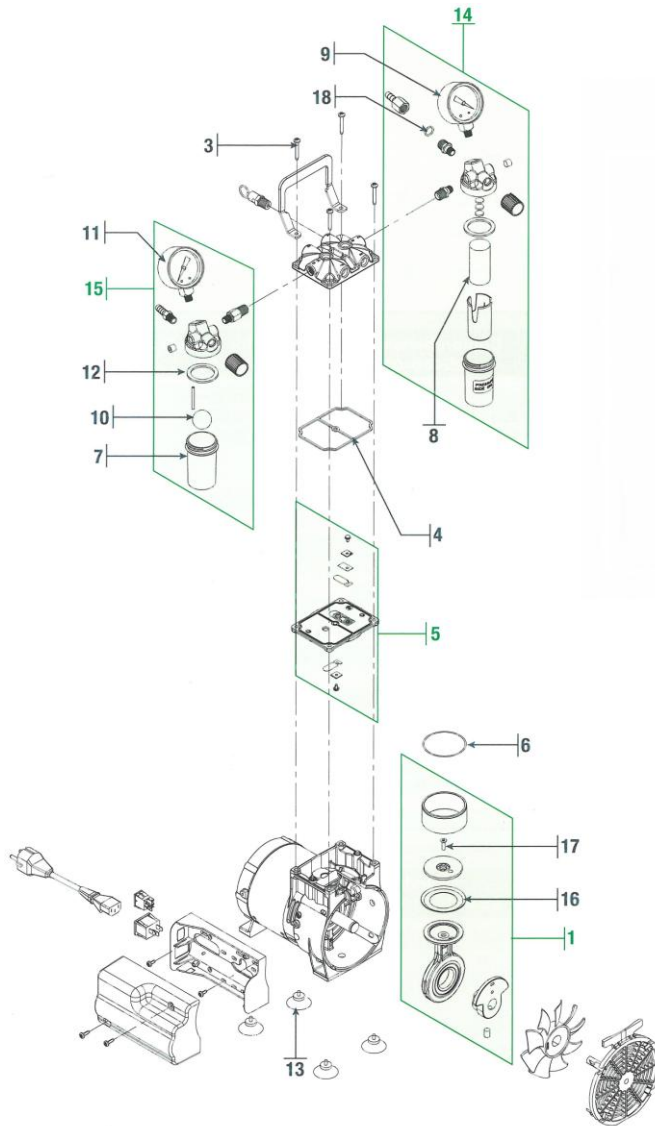

\* ) These parts are not sold separately, but are only available in respective kit.

Spare parts				Service-Kit	Seal-Kit	Foot-Kit
Item	Piece	Order no.	Designation	Order no. 2546K-03	Order no. 2546K-04	Order no. 2500K-04
1	1	2534K-01	Connecting rod Assembly	1	-	-
3	4	*)	Screw, Head	4	-	-
4	1	*)	Seal	1	1	-
5	1	2567K-02	Valve plate Assembly	1	-	-
6	1	*)	O-Ring	1	1	-
7	2	*)	Plastic Separator (suction / pressure)	2	2	-
8	1	*)	Filter element	1	1	-
9	1	726026	Pressure Manometer 230 V	-	-	-
10	1	*)	Ball	1	1	-
11	1	726024	Vacuum Manometer 230 V	-	-	-
12	2	*)	Seal	2	2	-
13	4	*)	Rubber suction feet	-	-	4
14	1	2522K-06	Pressure Regulator Assembly	-	-	-
15	1	2522K-05	Vacuum Regulator Assembly	-	-	-
16	1	*)	Piston cup	-	1	-
17	1	*)	Retainer screw	-	1	-
18	1	*)	O-Ring	1	1	-

# Spare Parts Overview

## 8.4 Spare parts view / Parts lists 2546C-02, 2546B-01

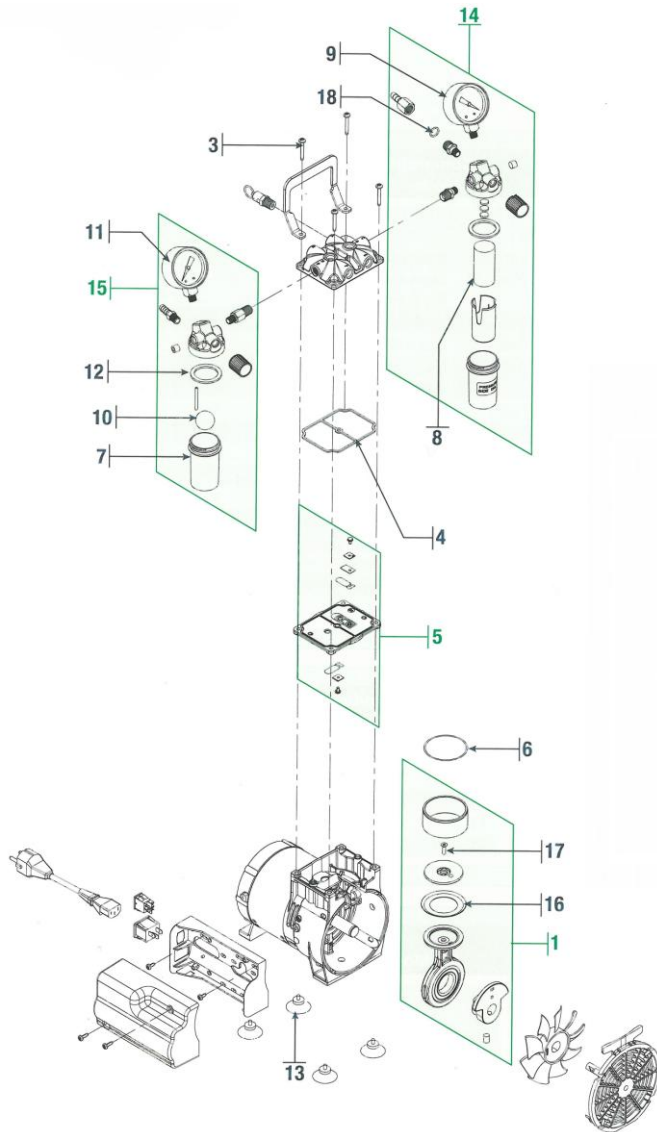

\*) These parts are not sold separately, but are only available in respective kit.

Spare parts				Service-Kit	Seal-Kit	Foot-Kit
Item	Piece	Order no.	Designation	Order no. 2546K-03	Order no. 2546K-04	Order no. 2500K-04
1	1	2546K-01	Connecting rod Assembly	1	-	-
3	4	*)	Screw, Head	4	-	-
4	1	*)	Seal	1	1	-
5	1	2567K-02	Valve plate Assembly	-	-	-
6	1	*)	O-Ring, Cylinder	1	1	-
7	2	*)	Plastic Separator (suction / pressure)	2	2	-
8	1	*)	Filter element	1	1	-
9	1	726026	Pressure Manometer 230 V	-	-	-
		726025	Pressure Manometer 115 V	-	-	-
10	1	*)	Ball	1	1	-
11	1	726024	Vacuum Manometer 230 V	-	-	-
		726021	Vacuum Manometer 115 V	-	-	-
12	2	*)	Seal	2	2	-
13	4	*)	Rubber suction feet	-	-	4
14	1	2522K-06	Pressure Regulator Assembly	-	-	-
15	1	2522K-05	Vacuum Regulator Assembly	-	-	-
16	1	*)	Piston cup	-	1	-
17	1	*)	Retainer screw	-	1	-
18	1	*)	O-Ring	1	1	-

# EG - Konformitätserklärung

EC Declaration of Conformity / CE Déclaration de Conformité / Declaración de conformidad  
DIN EN ISO / IEC 17050

(de) Hiermit erklären wir	 by Gardner Denver	Gardner Denver Thomas GmbH Am Vogelherd 20 98693 Ilmenau Germany	T +49 3677 604 0 F +49 3677 604 131 <a href="mailto:welch.emea@gardnerdenver.com">welch.emea@gardnerdenver.com</a> <a href="http://www.welchvacuum.com">www.welchvacuum.com</a>
unter eigener Verantwortung, dass nachstehendes Produkt aufgrund seiner Konzipierung und Bauart sowie in den von uns in Verkehr gebrachten Unterlagen den nachfolgend aufgeführten EG-Richtlinien und Normen entspricht. Bei einer nicht mit uns abgestimmten Änderung des Produkts verliert diese Erklärung ihre Gültigkeit.			
(en) We herewith declare under our sole responsibility that the product described below is in accordance with the following Directives standards and other technical specifications regarding design and version when delivered from our factory. This declaration becomes invalid whenever the product has been modified without our consent.			
(fr) Nous certifions par la présente, que le produit décrit ci-après est conforme, tant dans sa conception que dans sa réalisation, aux normes de sécurité et d'hygiène exigées par les standards de la CE. En cas de modification du produit sans notre accord, cette déclaration devient caduque.			
(es) Por la presente declaramos, bajo nuestra exclusiva responsabilidad, que el producto especificado a continuación cumple con las Directivas CE y las normas mencionadas a continuación en base a su concepción y construcción, así como a la versión puesta en el mercado por nuestra empresa. La presente declaración pierde su validez en caso de que se realicen modificaciones no autorizadas por nosotros en el producto.			

Bezeichnung des Produkts (Pumpen) / Description of product (pumps) / Description du produit (pompes) / Denominación del producto (bombas)	WOB-L® Kolbenpumpen / Piston pumps / Pompes à piston / Bombas de pistones 2522, 2534, 2546
Artikel-Nr. / Fabrication No. / No. de fabrication / N° artículo	2522C-02, 2534C-02, 2546C-02 2522B-01, 2534B-01, 2546B-01
Baujahr / Year of manufacture / Année de fabrication / Año de fabricación	2017

Das Produkt entspricht folgenden Richtlinien und Normen: / The product is in conformity with the following Directives and standards: / Le produit est conforme aux directives et standards suivants: / Este producto cumple las siguientes directivas y normas:		
X	2006/42/EG	Maschinenrichtlinie / EC machinery directive / directive CE sur les machines / Directiva sobre máquinas (17.05.2006)
X	2014/30/EU	Elektromagnetische Verträglichkeit / EC Electromagnetic Compatibility Directive / Directive CE relative à la compatibilité électromagnétique / Directiva sobre compatibilidad electromagnética
X	2011/65/EU	Gefährliche Stoffe in Elektro- und Elektronikgeräten (RoHS II) / Dangerous materials in electrical and electronics devices (RoHS II) / Substances dangereuses dans les appareils électriques et électroniques (RoHS II) / Sustancias peligrosas en aparatos eléctricos y electrónicos (RoHS II)
X	2012/19/EU	Elektro- und Elektronik - Altgeräte (WEEE) / Electrical and electronics - old devices (WEEE) / Électro et électronique - appareils de contralto (WEEE) / Residuos de aparatos eléctricos y electrónicos (RAEE)
X	China – RoHS II	Umweltschutzgesetz – China 2016-01 Environment protection law / Loi sur la protection de l'environnement / Ley de protección del medio ambiente

Angewandte harmonisierte Normen: / Applied harmonized standards: / Standards appliqués et harmonisés: / Normas armonizadas autorizadas:		
X	DIN EN ISO 12100:2011-03	Sicherheit von Maschinen - Allgemeine Gestaltungsleitsätze Risikobeurteilung und Risikominderung / Safety of machinery - General principles for design - Risk assessment and risk reduction / Sécurité des machines - / Principes généraux pour l'évaluation des risques et la réduction des risques / Seguridad de las máquinas. Principios generales para el diseño. Evaluación del riesgo y reducción del riesgo
X	DIN EN ISO 13857:2008-06	Sicherheit von Maschinen - Sicherheitsabstände gegen das Erreichen von Gefährdungsbereichen mit den oberen und unteren Gliedmaßen / Safety of machinery - Safety distances to prevent hazard zones being reached by upper and lower limbs / Sécurité des machines - Distances de sécurité empêchant les membres supérieurs et inférieurs d'atteindre les zones dangereuses / Seguridad de las máquinas. Distancias de seguridad para impedir que se alcancen zonas peligrosas con los miembros superiores e inferiores
X	DIN EN 1012-2: 2011-12	Kompressoren und Vakuumpumpen - Sicherheitsanforderungen - Teil 2: Vakuumpumpen / Compressors and vacuum pumps - Safety requirements - part 2: Vacuum pumps / Compresseurs et pompes à vide - Exigences de sécurité - partie 2: pompes à vide / Compresores y bombas de vacío. Requisitos de seguridad. Parte 2: Bombas de vacío
X	DIN EN ISO 2151:2009-01	Akustik - Geräuschmessnorm für Kompressoren und Vakuumpumpen - Verfahren der Genauigkeitsklasse 2 / Acoustics - Noise test code for compressors and vacuum pumps - Engineering method (grade 2) / Acoustique - norme de mesure des émissions pour les compresseurs et les pompes à vide - Procédé de classe de précision 2 / Acústica. Código de ensayo de ruido para compresores y bombas de vacío. Método de ingeniería (Clase de precisión 2)
X	DIN EN 60204-1: 2014-01	Sicherheit von Maschinen - Elektrische Ausrüstung von Maschinen - Teil 1: Allgemeine Anforderungen / Safety of machinery - Electrical equipment of machines - part 1: General requirements / Sécurité des machines - Equipement électrique des machines - partie 1: Prescriptions générales / Seguridad de las máquinas. Equipo eléctrico de las máquinas. Parte 1: Requisitos generales
X	EN 61000-6-2: 2011-06	Elektromagnetische Verträglichkeit (EMV) - Teil 6-2: Fachgrundnormen - Störfestigkeit für Industriebereiche / Electromagnetic compatibility (EMC) - part 6-2: Generic standards - Immunity for industrial environments / Compatibilité électromagnétique (EMV) - partie 6-2: Normes génériques - Immunité pour les environnements industriels / Compatibilidad electromagnética (CEM). Parte 6-2: Normas genéricas. Inmunidad en el entorno industrial
X	EN 61000-6-4: 2011-09	Elektromagnetische Verträglichkeit (EMV) - Teil 6-4: Fachgrundnormen - Störaussendung für Industriebereiche / Electromagnetic compatibility (EMC) - part 6-4: Generic standards - Emission standard for industrial environments / Compatibilité électromagnétique (EMV) - partie 6-4: Normes génériques - Emissions de parasites pour les activités industrielles / Compatibilidad electromagnética (CEM). Parte 6-4: Normas genéricas. Norma de emisión en entornos industriales
X	DIN EN 50110-1: 2014-02	Betrieb von elektrischen Anlagen / Operation of electrical installations / Fonctionnement des installations électriques / Funcionamiento de instalaciones eléctricas
X	DIN EN 61010-1/A1:2015-04	Sicherheitsbestimmungen für elektrische Mess-, Steuer-, Regel- und Laborgeräte - Teil 1: Allgemeine Anforderungen / Safety requirements for electrical equipment for measurement, control and laboratory use - part 1: General requirements / Consignes de sécurité pour les appareils électriques de mesure, de commande, de régulation ou de laboratoire - partie 1: Prescriptions générales / Disposiciones de seguridad para medidores, equipos de mando, equipos reguladores y equipos de laboratorio. Parte 1: Requisitos generales

Datum / Data / Fecha	2017-02-15	
Qualitätsbeauftragter / Quality representative / Délégué de qualité / Responsable de calidad	Name / Name / Nom / Nombre	
Produktmanager / Product manager / Directeur de produit / Jefe de producto	Name / Name / Nom / Nombre	